

# NOZBART®

*The best of the world...*



# 160

Farklı nozul..

*Different nozzles...*



PLASTİK VE MAKİNA KALIP SANAYİ VE TİCARET LİMİTED ŞİRKETİ

- ▶ Besleme nozullarında yeni mükemmel tasarım 80 farklı çeşidiyle en geniş kullanım alanı  
*New excellent design inlets and wide range of applications with 80 different types*
- ▶ Beton, liner, panel ve polyester her türlü havuza uygun nozullar ile geniş ürün yelpazesi.  
*Wide range of inlets suitable for all kinds of pools: Concrete, liner, panel, polyester*
- ▶ Anahtarla sıkma segmanı sıkılarak küre sabitlenir. Piyasadaki diğer modeller gibi yüzücülerin nozul kapağını sökmesiyle küre havuz içine düşmez.  
*The ball is fixed by tightening squeeze ring with key. Ball doesn't fall into pool (contrarily of other models on the market) when swimmers remove the nozzle cover.*

- ▶ Nozul gövdesinin içindeki parçalar birbiriyle uyumludur. İsteğinize göre;  
*Parts inside the inlet body are compatible with each other. Can be used and changed easily, optionally as;*

Çeşitli debilerde küreli yandan besleme nozulu,  
*Wall inlet with pivoting ball on different flows*

Debi ayarlı tabandan besleme nozulu,  
*Adjustable floor inlet*

Yandan çıkışlı besleme nozulu,  
*Output side inlet*

Kafesli (sabit debili) besleme - emiş nozulu  
*Fixed-flow floor inlet-suction with safety cage*

Vakum nozulu olarak zahmetsizce değiştirip kullanılabilir.  
*Suction inlet*



Debi ayarını yapın yıldız tornavida ile vidayı sıkarak sabitleyin !  
*Adjust the flow rate and tighten the screw with a screwdriver!*

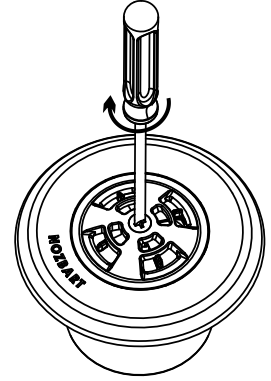

- ▶ Yapıştırılmalı modeller 63 mm U-PVC (PN10) borunun içine yapıştırılabilir.  
*Solvent models can be glued into a 63 mm U-PVC (PN10) pipe.*
- ▶ Dişli modeller 2" boru dişlidir. Bütün modellerin içine 50 mm U-PVC boru yapıştırılabilir.  
*Threaded models are 2" pipe threaded. 50 mm U-PVC pipe can be glued into all models.*
- ▶ Mafsallı modeller yapıştırma tarafındaki tam küre tasarımı ile 10 dereceye kadar tesisat hatalarında sorunsuz montaj sağlar.  
*Hinged models with complete ball design on solvent side, provide smooth mounting on installations up to 10 degrees errors.*
- ▶ Küreli besleme nozulları 2,2 - 4,5 - 7 m<sup>3</sup>/saat debili olarak özel üretilmiştir. Bu nedenle piyasada mevcut diğer modellerde olduğu gibi küreyi kırmak için ilave işçilik ve aparat gereksinimi bulunmaz. İstedığınız debi değerinde kullanılmaya hazırdır.  
*Inlets with pivoting ball are produced as flow of 2,2 - 4,5 - 7 m<sup>3</sup>/hour. Therefore no additional workmanship and apparatus are required to break the ball as in other models available in the market. It is ready to be used at the desired flow rate.*
- ▶ Nozullar orjinal ABS malzemeden üretilmiştir. UV ve antioksidant katkı, uzun ömürlüdür.  
*Nozzles are produced from original ABS material reinforced with UV and antioxidant.*
- ▶ Küreli (Emniyet kafesli) ve tabandan besleme nozullarımız EN 13451-3'e uygundur.  
*Wall inlet with pivoting ball and floor inlets with safety cage are suitable to EN 13451-3.*
- ▶ Parmak sıkışma emniyetli olup delikler 8 mm'den küçüktür.  
*Finger jam is secure and the holes are smaller than 8 mm.*
- ▶ Tabandan besleme nozulları özel tasarımı ile havuz zeminindeki suyu hareketlendirir. Zemin kirini yüzeye çıkartarak taşma kanallarından veya skimmerden geçerek havuzu terk etmesine yardımcı olur. Havuz zemininin temiz kalmasını sağlar.  
*Floor inlets set in motion water in pool floor with its special design, help floor dirt to go on surface and to leave pool by passing through overflow channels or skimmer; allows pool floor to keep clean.*
- ▶ Debi ayarlı nozullar, hassas debi ayarına imkân verir. Bir kez ayarlandığında üstteki civatası sıkılarak sabit hale gelir, konumu değişmez ve mükemmel bir havuz dengesi sağlar.  
*Adjustable floor inlets allow accurate flow adjustment. Once set, it is fixed by tightening top bolts. Its position doesn't change and provides excellent pool stability.*
- ▶ Vakum nozulu içten tırnaksızdır. Kırmaya gerek kalmaksızın, hortum koniği engelsiz olarak içeri itilerek sabitlenebilir.  
*The vacuum nozzle is internally hollow. Without the need to break, the hose cone can be pushed in without difficulty.*



## BETON Havuzlar / CONCRETE Pools

YENİ ÜRÜN  
NEW PRODUCT

Model	Debi m³/saat	63 mm U-PVC PN10 Yapıştırma (Solvent)	Mafsallı (63 mm PN10) Hinged (63 mm PN10)	2" Dişli (Threaded)	
		İç - Inside 50 mm Yapıştırma (Solvent)	Yapıştırma (Solvent)	İç - Inside 50 mm Yapıştırma (Solvent)	
		24 adet/koli pcs/box	30 adet/koli pcs/box	24 adet/koli pcs/box	
		Kod / Code	Kod / Code	Kod / Code	
Kürelü Yandan Besleme Nozulu <i>Wall Inlet with Pivoting Ball</i>	Ø17,5 mm Emniyet kafesli <i>Safety cage</i>	2,2	NOZ-101	NOZ-201	NOZ-301
	Ø22,8 mm Emniyet kafesli <i>Safety cage</i>	4,5	NOZ-102	NOZ-202	NOZ-302
	Ø27,0 mm Emniyet kafesli <i>Safety cage</i>	7	NOZ-103	NOZ-203	NOZ-303
	Ø20 mm Kafessiz <i>Full Bore</i>	4,5	NOZ-104	NOZ-204	NOZ-304
Debi Ayarlı Tabandan Besleme Nozulu <i>Adjustable Floor Inlet</i>		0-4,5	NOZ-105	NOZ-205	NOZ-305
			NOZ-105D	NOZ-205D	NOZ-305D
Yandan Çıkışlı Tabandan Besleme Nozulu <i>Output Side Floor Inlet</i>		4,5	NOZ-106	NOZ-206	NOZ-306
Kafesli Besleme ve Emme Nozulu <i>Floor Inlet and Suction with Safety Cage</i>			NOZ-107	NOZ-207	NOZ-307
	Besleme - <i>Inlet</i> (10 m³/saat) Emiş - <i>Suction</i> (1,25 m³/saat)		NOZ-107D	NOZ-207D	NOZ-307D
Vakum Nozulu <i>Suction Inlet</i>		7	NOZ-108	NOZ-208	NOZ-308

Beton  
Concrete

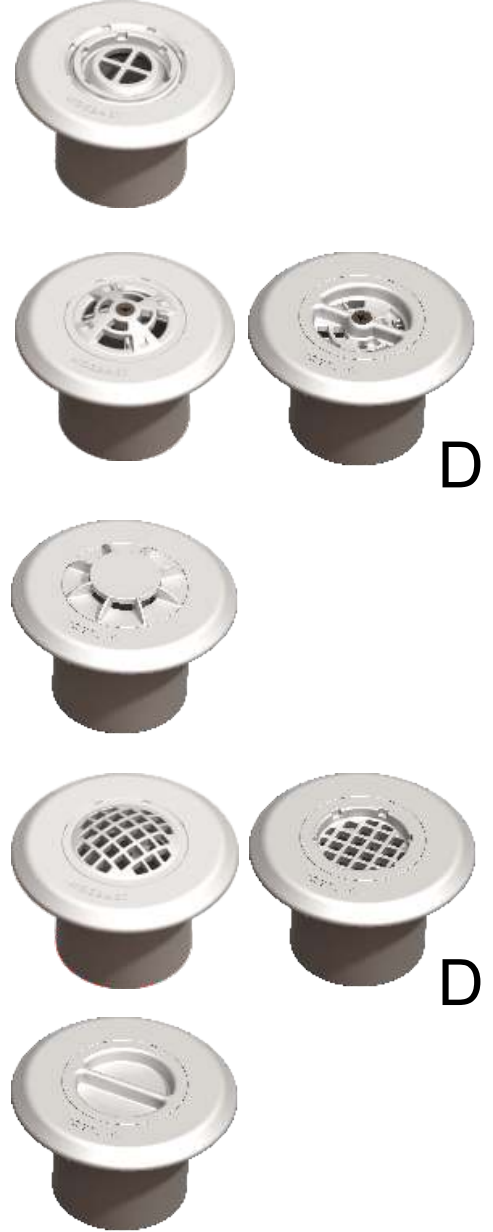



## LİNER Havuzlar / LINER Pools

YENİ ÜRÜN  
NEW PRODUCT

Liner  
Polyester

Model		Debi m <sup>3</sup> /saat	63 mm U-PVC PN10 Yapıştırma (Solvent)	Mafsallı (63 mm PN10) Hinged (63 mm PN10)	2" Dişli (Threaded)
Sarı vida yuvalı with brass insert			İç - Inside 50 mm Yapıştırma (Solvent)	Yapıştırma (Solvent)	İç - Inside 50 mm Yapıştırma (Solvent)
			18 adet/koli pcs/box	24 adet/koli pcs/box	18 adet/koli pcs/box
			Kod / Code	Kod / Code	Kod / Code
Kürelü Yandan Besleme Nozulu	Ø17,5 mm Emniyet kafesli Safety cage	2,2	NOZ-401	NOZ-501	NOZ-601
	Ø22,8 mm Emniyet kafesli Safety cage	4,5	NOZ-402	NOZ-502	NOZ-602
Wall Inlet with Pivoting Ball	Ø27,0 mm Emniyet kafesli Safety cage	7	NOZ-403	NOZ-503	NOZ-603
	Ø20 mm Kafesiz Full Bore	4,5	NOZ-404	NOZ-504	NOZ-604
Debi Ayarlı Tabandan Besleme Nozulu	Adjustable Floor Inlet	0-4,5	NOZ-405	NOZ-505	NOZ-605
			NOZ-405D	NOZ-505D	NOZ-605D
Yandan Çıkışlı Tabandan Besleme Nozulu	Output Side Floor Inlet	4,5	NOZ-406	NOZ-506	NOZ-606
Kafesli Besleme ve Emme Nozulu Floor Inlet and Suction with Safety Cage			NOZ-407	NOZ-507	NOZ-607
Besleme - Inlet (10 m <sup>3</sup> /saat) Emiş - Suction (1,25 m <sup>3</sup> /saat)			NOZ-407D	NOZ-507D	NOZ-607D
Vakum Nozulu Suction Inlet		7	NOZ-408	NOZ-508	NOZ-608



## PANEL Havuzlar / PANEL Pools

**YENİ ÜRÜN**  
**NEW PRODUCT**

Model		Debi m <sup>3</sup> /saat	2" Dişli (Threaded)
			İç - Inside 50 mm Yapıştırma (Solvent)
		18 adet/koli pcs/box	Kod / Code
Kürel Yandan Besleme Nozulu <i>Wall Inlet Nozzle Pivoting Ball</i>	Ø17,5 mm Küre Emniyet kafesi <i>Safety cage</i>	2,2	NOZ-701
	Ø22,8 mm Küre Emniyet kafesi <i>Safety cage</i>	4,5	NOZ-702
	Ø27,0 mm Küre Emniyet kafesi <i>Safety cage</i>	7	NOZ-703
	Ø20 mm Kafessiz <i>Full Bore</i>	4,5	NOZ-704
Debi Ayarlı Tabandan Besleme Nozulu <i>Adjustable Floor Inlet</i>		0-4,5	NOZ-705
			NOZ-705D
Yandan Çıkışlı Tabandan Besleme Nozulu <i>Floor Inlet Side Output</i>		4,5	NOZ-706
Kafesli Besleme ve Emme Nozulu <i>Floor Inlet and Suction with Safety Cage</i>			NOZ-707
Besleme - <i>Inlet</i> (10 m <sup>3</sup> /saat) Emiş - <i>Suction</i> (1,25 m <sup>3</sup> /saat)			NOZ-707D
Vakum Nozulu <i>Suction Inlet</i>		7	NOZ-708

Panel



D



D



**POLYESTER Havuzlar / POLYESTER Pools**

**YENİ ÜRÜN  
NEW PRODUCT**

Polyester

Model		Debi m <sup>3</sup> /saat	2" Dişli (Threaded)
Sarı vida yuvalı with brass insert			İç - Inside 50 mm Yapıştırma (Solvent)
		24 adet/koli pcs/box	Kod / Code
Kürel Yandan Besleme Nozulu <i>Wall Inlet Nozzle Pivoting Ball</i>	Ø17,5 mm Küre Emniyet kafesi <i>Safety cage</i>	2,2	NOZ-801
	Ø22,8 mm Küre Emniyet kafesi <i>Safety cage</i>	4,5	NOZ-802
	Ø27,0 mm Küre Emniyet kafesi <i>Safety cage</i>	7	NOZ-803
	Ø20 mm Kafessiz <i>Full Bore</i>	4,5	NOZ-804
Debi Ayarlı Tabandan Besleme Nozulu <i>Adjustable Floor Inlet</i>		0-4,5	NOZ-805
			NOZ-805D
Yandan Çıkışlı Tabandan Besleme Nozulu <i>Floor Inlet Side Output</i>		4,5	NOZ-806
Kafesli Besleme ve Emme Nozulu <i>Floor Inlet and Suction with Safety Cage</i>			NOZ-807
Besleme - Inlet (10 m <sup>3</sup> /saat) Emiş - Suction (1,25 m <sup>3</sup> /saat)			NOZ-807D
Vakum Nozulu <i>Suction Inlet</i>		7	NOZ-808





Beton  
Concrete

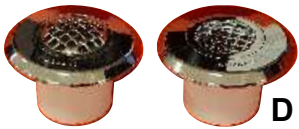

## BETON Havuzlar / CONCRETE Pools

Model	Debi m³/saat	63 mm U-PVC PN10 Yapıştırma (Solvent)	Mafsallı (63 mm PN10) Hinged (63 mm PN10)	2" Dişli (Threaded)	
		İç - Inside 50 mm Yapıştırma (Solvent)	Yapıştırma (Solvent)	İç - Inside 50 mm Yapıştırma (Solvent)	
		Kod / Code	Kod / Code	Kod / Code	
Kürelü Yandan Besleme Nozulu (Krom)  Wall Inlet with Pivoting Ball (Chrome)	Ø17,5 mm Emniyet kafesli Safety cage	2,2	NOZ-101K	NOZ-201K	NOZ-301K
	Ø22,8 mm Emniyet kafesli Safety cage	4,5	NOZ-102K	NOZ-202K	NOZ-302K
	Ø27,0 mm Emniyet kafesli Safety cage	7	NOZ-103K	NOZ-203K	NOZ-303K
	Ø20 mm Kafesiz Full Bore	4,5	NOZ-104K	NOZ-204K	NOZ-304K
Debi Ayarlı Tabandan Besleme Nozulu (Krom)  Adjustable Floor Inlet (Chrome)		0-4,5	NOZ-105K	NOZ-205K	NOZ-305K
			NOZ-105DK	NOZ-205DK	NOZ-305DK
Yandan Çıkışı Tabandan Besleme Nozulu (Krom)  Output Side Floor Inlet (Chrome)		4,5	NOZ-106K	NOZ-206K	NOZ-306K
Kafesli Besleme ve Emme Nozulu (Krom)  Floor Inlet and Suction with Safety Cage (Chrome)			NOZ-107K	NOZ-207K	NOZ-307K
	Besleme - Inlet (10 m³/saat) Emiş - Suction (1,25 m³/saat)		NOZ-107DK	NOZ-207DK	NOZ-307DK
Vakum Nozulu (Krom)  Suction Inlet (Chrome)		7	NOZ-108K	NOZ-208K	NOZ-308K

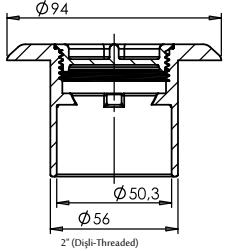
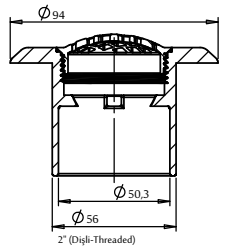
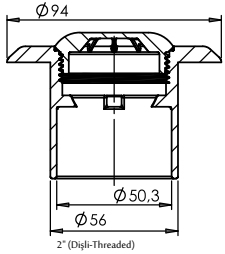
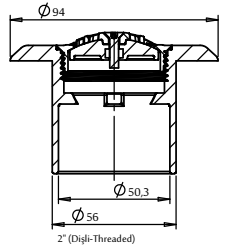
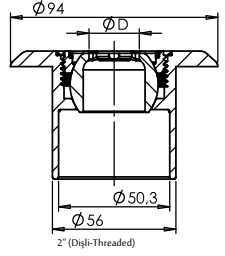

Nozullar orjinal ABS malzemeden üretilmiştir. UV ve antioksidant katkı, uzun ömürlüdür.

Nozzles are produced from original ABS material reinforced with UV and antioxidant.

Kürelü (Emniyet kafesli) ve tabandan besleme nozullarımız EN 13451-3'e uygundur.

Wall inlet with pivoting ball and floor inlets with safety cage are suitable to EN 13451-3.

Parmak sıkışma emniyetli olup delikler 8 mm'den küçüktür.

Finger jam is secure and the holes are smaller than 8 mm.

Yapıştırma ürünler 10 Bar 63 mm U-PVC borunun içine yapıştırmaya uygundur.

To be glued into a 63 mm PN-10 pipe.



## LİNER Havuzlar / LINER Pools

Model		Debi m <sup>3</sup> /saat	63 mm U-PVC PN10 Yapıştırma (Solvent)	Mafsallı (63 mm PN10) Hinged (63 mm PN10)	2" Dişli (Threaded)
Sarı vida yuvalı with brass insert			İç - Inside 50 mm Yapıştırma (Solvent)	Yapıştırma (Solvent)	İç - Inside 50 mm Yapıştırma (Solvent)
		Kod / Code	Kod / Code	Kod / Code	
Kürelî Yandan Besleme Nozulu (Krom)	Ø17,5 mm Emniyet kafesli Safety cage	2,2	NOZ-401K	NOZ-501K	NOZ-601K
	Ø22,8 mm Emniyet kafesli Safety cage	4,5	NOZ-402K	NOZ-502K	NOZ-602K
	Ø27,0 mm Emniyet kafesli Safety cage	7	NOZ-403K	NOZ-503K	NOZ-603K
Wall Inlet with Pivoting Ball (Chrome)	Ø20 mm Kafesiz Full Bore	4,5	NOZ-404K	NOZ-504K	NOZ-604K
Debi Ayarlı Tabandan Besleme Nozulu (Krom)		0-4,5	NOZ-405K	NOZ-505K	NOZ-605K
	Adjustable Floor Inlet (Chrome)		NOZ-405DK	NOZ-505DK	NOZ-605DK
Yandan Çıkışlı Tabandan Besleme Nozulu (Krom)		4,5	NOZ-406K	NOZ-506K	NOZ-606K
Output Side Floor Inlet (Chrome)					
Kafesli Besleme ve Emme Nozulu Floor Inlet and Suction with Safety Cage			NOZ-407K	NOZ-507K	NOZ-607K
	Besleme - Inlet (10 m <sup>3</sup> /saat) Emiş - Suction (1,25 m <sup>3</sup> /saat)		NOZ-407DK	NOZ-507DK	NOZ-607DK
Vakum Nozulu Suction Inlet		7	NOZ-408K	NOZ-508K	NOZ-608K

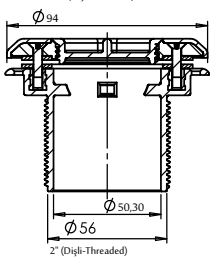
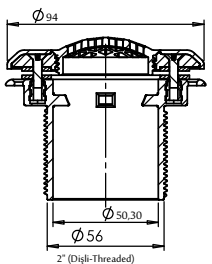
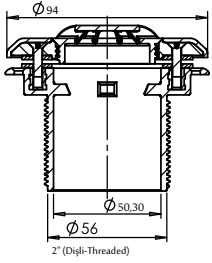
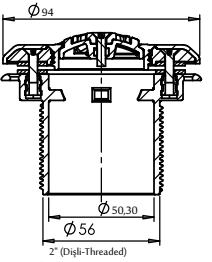
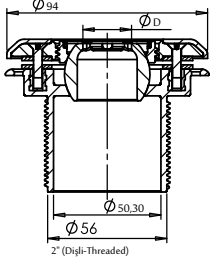

Liner  
Polyester

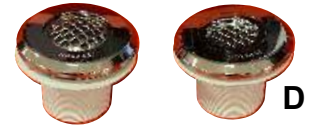
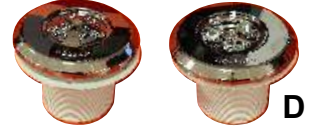

Nozullar orjinal ABS malzemeden üretilmiştir.

Nozzles were produced from original ABS material.

Kürelî (Emniyet kafesli) ve tabandan besleme nozullarımız EN 13451-3'e uygundur.

It is suitable for EN 13451-3 with globe (safety cage) and bottom nozzle.

Parmak sıkışma emniyetli olup delikler 8 mm'den küçüktür.

Finger jam is secure and the holes are 8 mm smaller.

Yapıştırma ürünler 10 Bar 63 mm U-PVC borunun içine yapıştırmaya uygundur.

To be glued into a 63 mm PN-10 pipe.



YENİ ÜRÜN  
NEW PRODUCT

Panel



D



D



## PANEL Havuzlar / PANEL Pools

Model	Debi m³/saat	2" Dişli (Threaded)	
		İç - Inside 50 mm Yapıştırma (Solvent)	Kod / Code
Kürel Yandan Besleme Nozulu <i>Wall Inlet Nozzle Pivoting Ball</i>	Ø17,5 mm Küre Emniyet kafesli <i>Safety cage</i>	2,2	NOZ-701K
	Ø22,8 mm Küre Emniyet kafesli <i>Safety cage</i>	4,5	NOZ-702K
	Ø27,0 mm Küre Emniyet kafesli <i>Safety cage</i>	7	NOZ-703K
	Ø20 mm Kafesiz <i>Full Bore</i>	4,5	NOZ-704K
Debi Ayarlı Tabandan Besleme Nozulu <i>Adjustable Floor Inlet</i>		0-4,5	NOZ-705K
			NOZ-705DK
Yandan Çıkışı Tabandan Besleme Nozulu <i>Floor Inlet Side Output</i>		4,5	NOZ-706K
Kafesli Besleme ve Emme Nozulu <i>Floor Inlet and Suction with Safety Cage</i>	Besleme - Inlet (10 m³/saat) Emiş - Suction (1,25 m³/saat)		NOZ-707K
			NOZ-707DK
Vakum Nozulu <i>Suction Inlet</i>		7	NOZ-708K

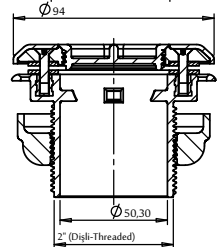
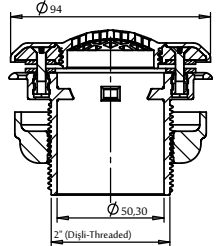
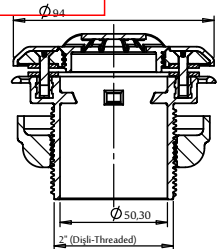
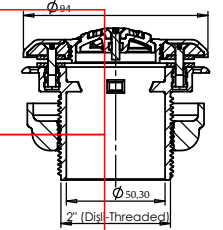
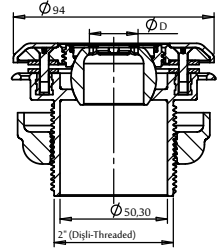

Nozullar orjinal ABS malzemeden üretilmiştir.

Nozzles were produced from original ABS material.

Kürel (Emniyet kafesli) ve tabandan besleme nozullarımız EN 13451-3'e uygundur.

It is suitable for EN 13451-3 with globe (safety cage) and bottom nozzle.

Parmak sıkışma emniyetli olup delikler 8 mm'den küçüktür.

Finger jam is secure and the holes are 8 mm smaller.

YENİ ÜRÜN  
NEW PRODUCT

Polyester

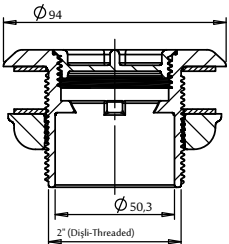
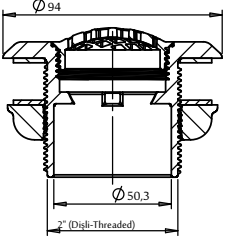
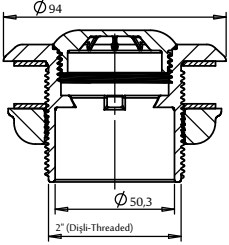
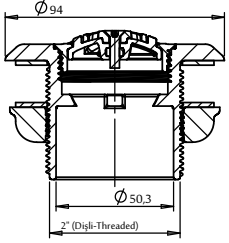
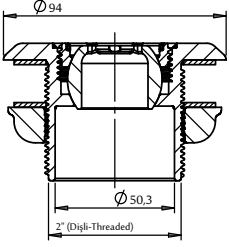

## POLYESTER Havuzlar / POLYESTER Pools

Model	Debi m <sup>3</sup> /saat	2" Dişli (Threaded)	
		İç - Inside 50 mm Yapıştırma (Solvent)	Kod / Code
Kürelü Yandan Besleme Nozulu <i>Wall Inlet Nozzle Pivoting Ball</i>	Ø17,5 mm Küre Emniyet kafesli <i>Safety cage</i>	2,2	NOZ-801K
	Ø22,8 mm Küre Emniyet kafesli <i>Safety cage</i>	4,5	NOZ-802K
	Ø27,0 mm Küre Emniyet kafesli <i>Safety cage</i>	7	NOZ-803K
	Ø20 mm Kafessiz <i>Full Bore</i>	4,5	NOZ-804K
Debi Ayarlı Tabandan Besleme Nozulu <i>Adjustable Floor Inlet</i>	0-4,5	NOZ-805K NOZ-805DK	
Yandan Çıkışı Tabandan Besleme Nozulu <i>Floor Inlet Side Output</i>	4,5	NOZ-806K	
Kafesli Besleme ve Emme Nozulu <i>Floor Inlet and Suction with Safety Cage</i>		NOZ-807K NOZ-807DK	
Besleme - Inlet (10 m <sup>3</sup> /saat) Emiş - Suction (1,25 m <sup>3</sup> /saat)			
Vakum Nozulu <i>Suction Inlet</i>	7	NOZ-808K	



Nozullar orjinal ABS malzemeden üretilmiştir.

Nozzles were produced from original ABS material.

Kürelü (Emniyet kafesli) ve tabandan besleme nozullarımız EN 13451-3'e uygundur.

It is suitable for EN 13451-3 with globe (safety cage) and bottom nozzle.

Parmak sıkışma emniyetli olup delikler 8 mm'den küçüktür.

Finger jam is secure and the holes are 8 mm smaller.

## Beton Havuz Nozulları Concrete Pool Nozzles

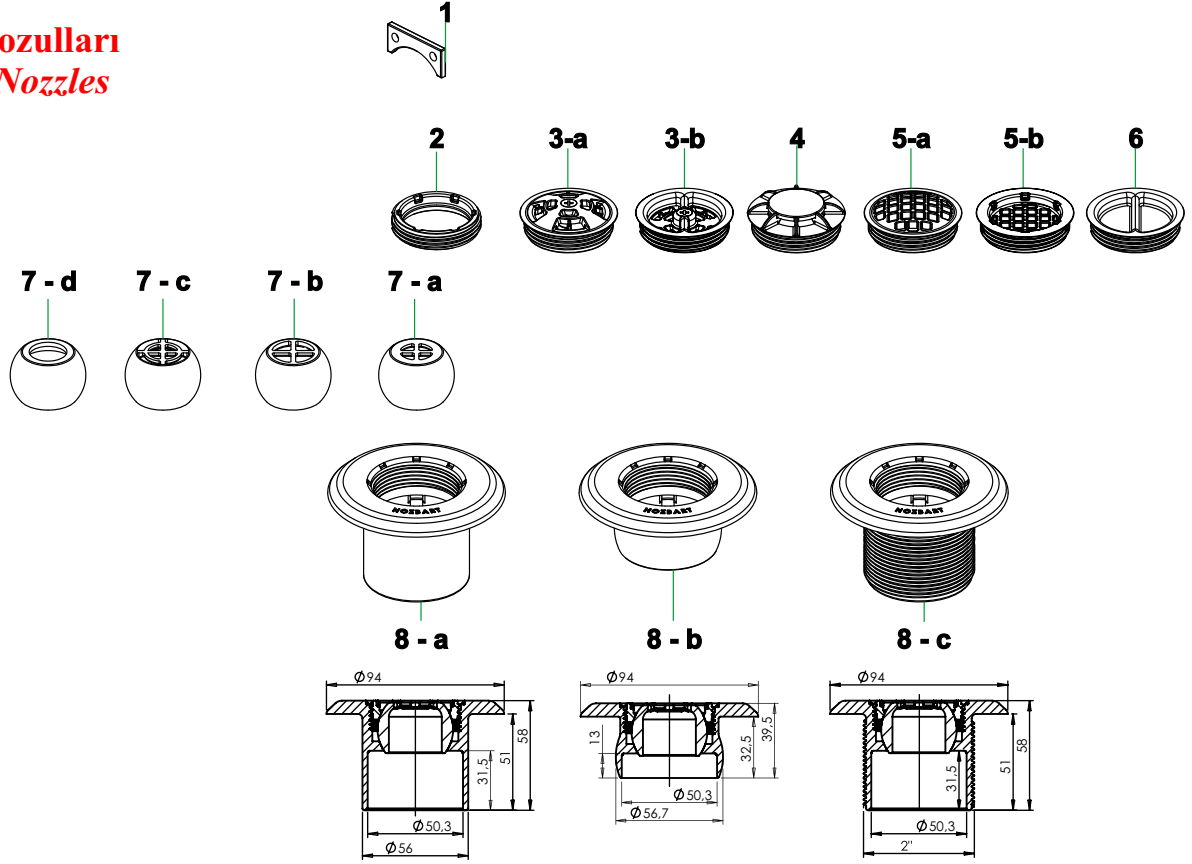

## Liner Havuz Nozulları Liner Pool Nozzles

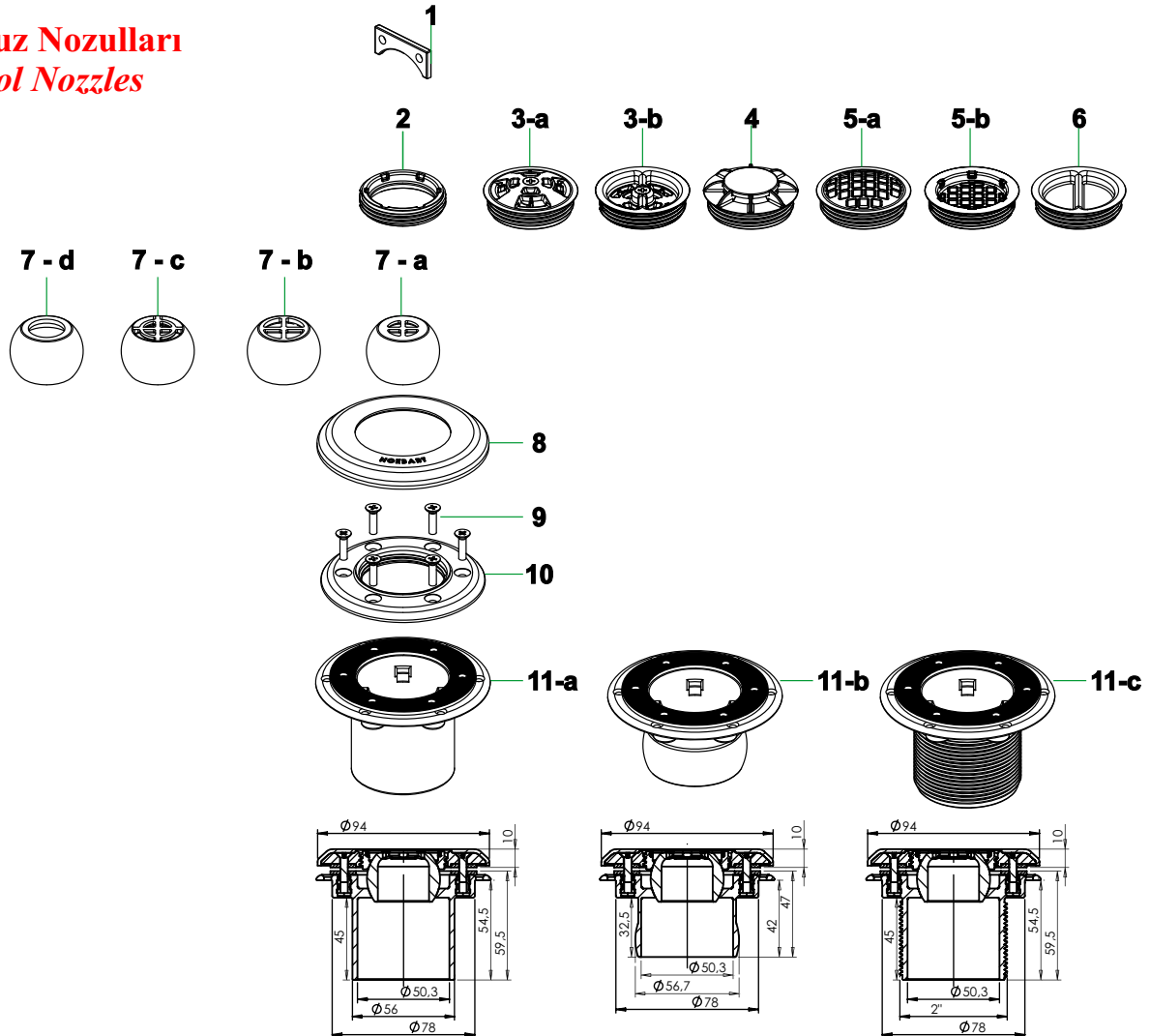



**Panel Havuz Nozulları**  
*Panel Pool Nozzles*

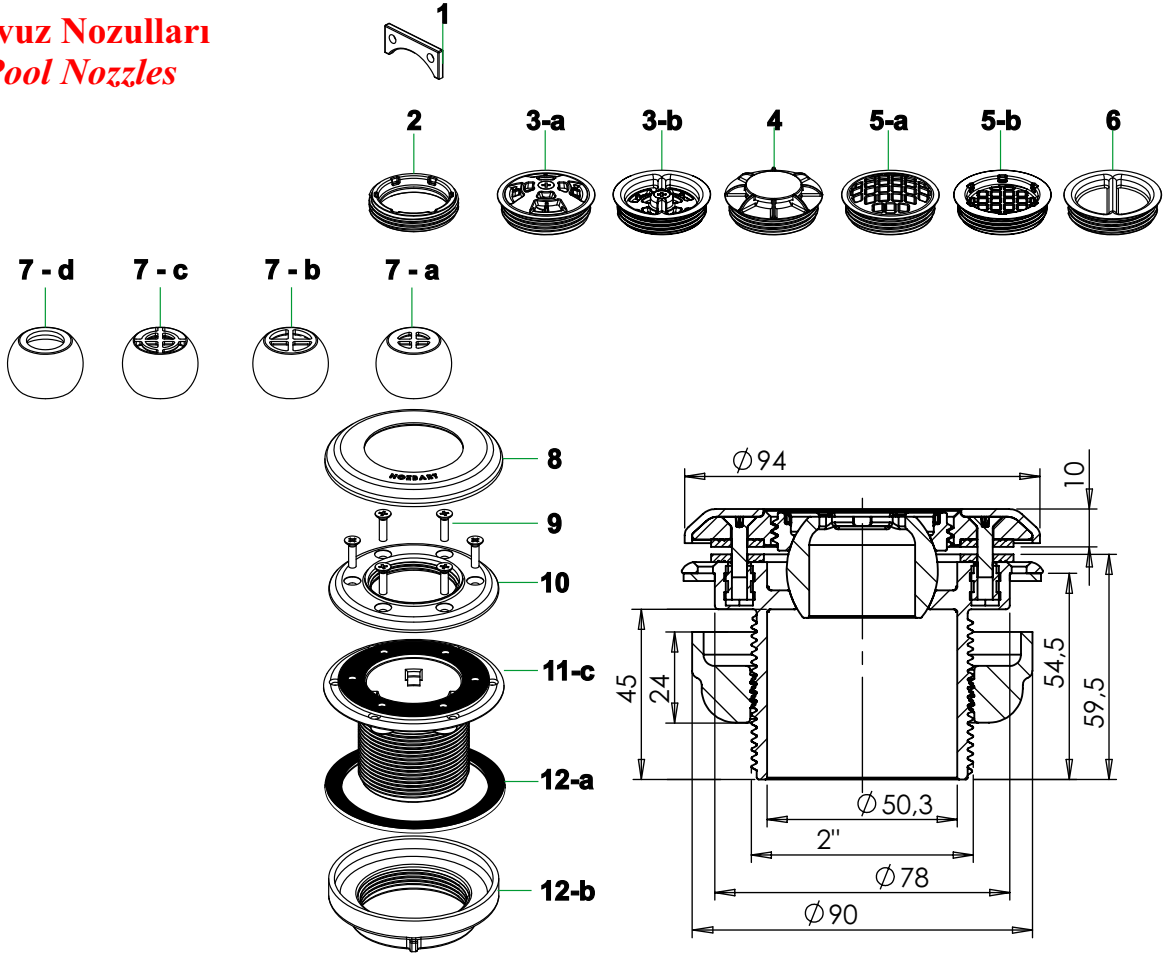

**Polyester Havuz Nozulları**  
*Polyester Pool Nozzles*

